

WISENET Road AI LPR/ANPR Cameras QUICK REFERENCE GUIDE



- 1 PRE-INSTALLATION
- 2 INSTALLING AND POSITIONING CAMERA
- 3 CONFIGURING YOUR CAMERA

Color **RED**

Brand **HTV**

Model **HT230C**

LPN **HT-777-WS**

Type **SUV**



CONTENTS

1

PRE-INSTALLATION

1.1 Choosing a Location

2

INSTALLING AND POSITIONING CAMERA

- 2.1 Camera Installation
- 2.2 Adjust for Plate "Rotation" Angle
- 2.3 LPR(ANPR)/ MMCR Specification

3

CONFIGURING YOUR CAMERA

- 3.1 Field of View
- 3.2 Configure Initial Camera Settings
- 3.3 Simple Focus on Plate Read Area
- 3.4 To measure pixel width of license/number plate
- 3.5 Observing Proper Installation
- 3.6 Examples of Improper Install

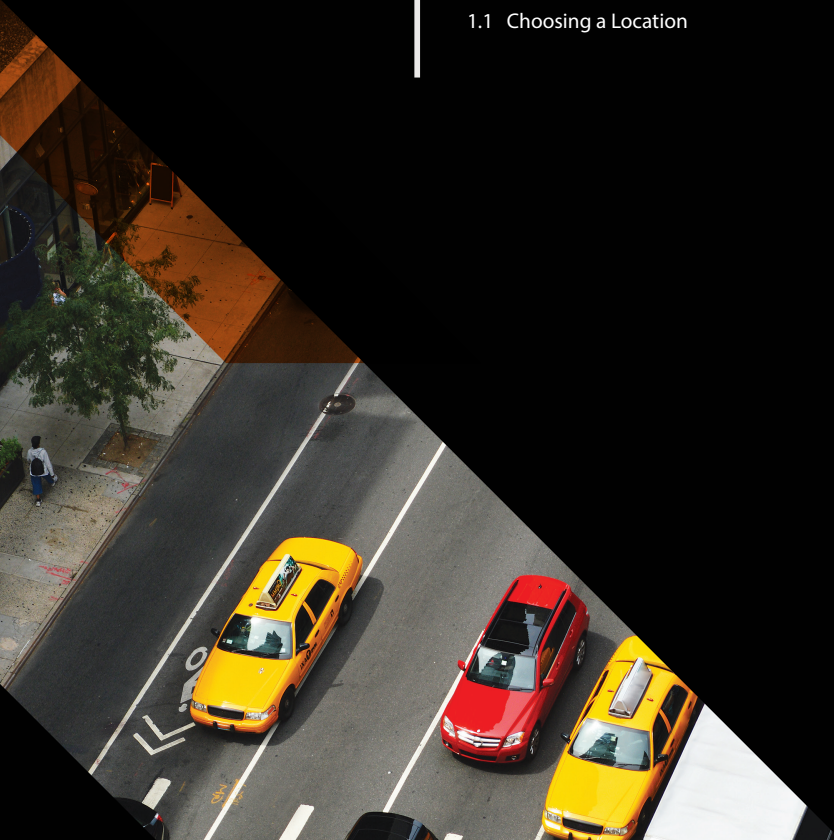

1 PRE-INSTALLATION

1.1 Choosing a Location

The LPR (License Plate Recognition)/ ANPR (Automatic Number Plate Recognition) Technology running on this camera will provide you with the best results when following the recommended installation constraints below.

Fig. 1
Camera shown from side

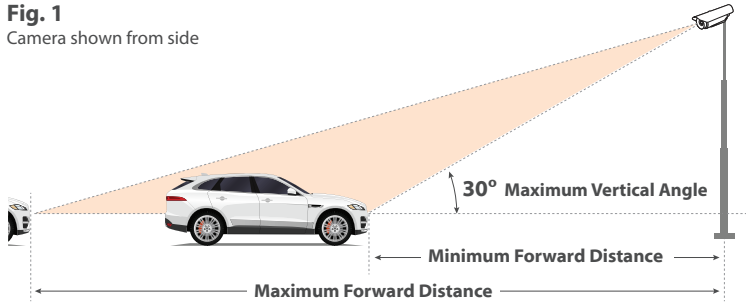

Recommended

30 degrees Maximum Vertical Angle
Maximum Forward Distance depends on lens zoom, however should not exceed **20 m / 65.6 ft** considering effective IR range (for PNO and PNV models). Please consider using external IR for ranges above 20 m / 65.6 ft.

Fig. 2
Example of installation at a height of 5 m

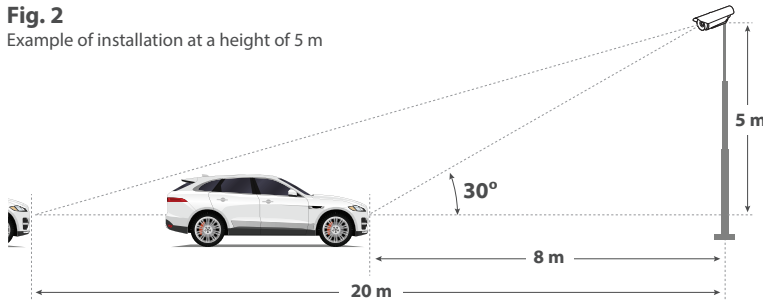

1.1 (Continued)

FORWARD DISTANCE TABLES

The **orange dots** on the tables below are recommended installation measurements.

[PNO/PNV-A9081RLP]

Camera Height (m)	Forward Distance (m)							
	6 (19.6')	8 (26.2')	10 (32.8')	12 (39.3')	14 (45.9')	18 (59.0')	19 (62.3')	20 (65.6')
5(16.4')		•	•	•	•	•	•	•
6(19.6')			•	•	•	•	•	•
7(22.9')				•	•	•	•	
8(26.2')					•	•		

* Day and night conditions with built in IR

* PNB-A9001LP parameters depends on lens & external IR.

1.1 (Continued)

Recommended

30 degrees Maximum Horizontal Angle

Fig. 3

Camera shown from top

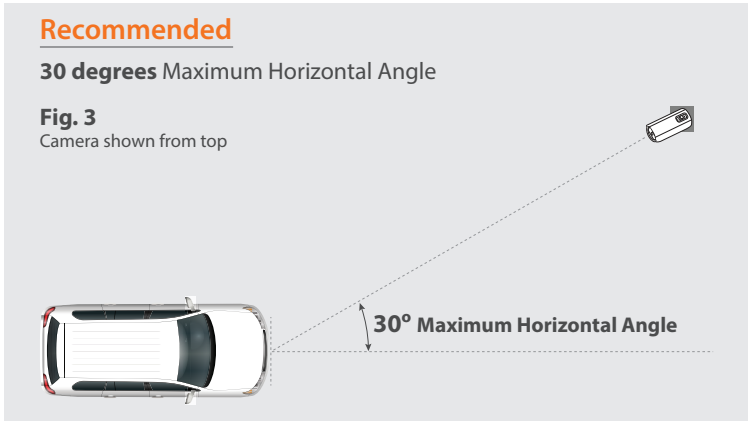
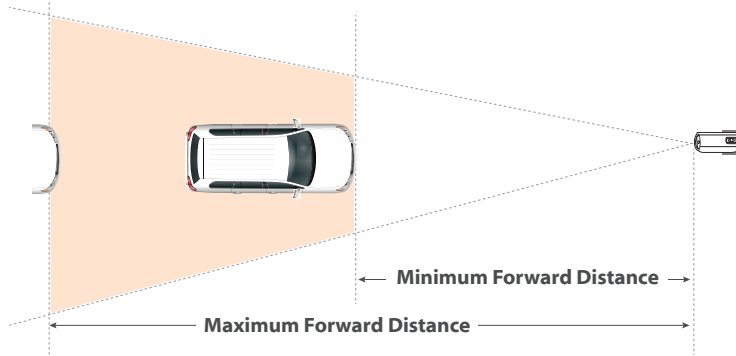

Fig. 4



Camera in 4K mode can cover up to 3 road lanes.
The FullHD mode can cover up to 2 lanes.

Normally, setting recognition zone (see orange frame below) in lower half of camera view is sufficient and favours app performance.

Best results are achieved when single row number plate width has fit the criteria. Greater width may affect performance.

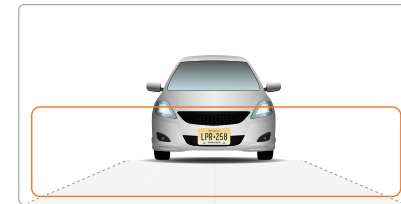

All the license Plate that are meeting the pixel criteria as below will be recognized in the selected area.

- **130-300 pixels** for regular EU plates
- **80-300 pixels** for US plates without stacked symbols (small ones)
- **160-300 pixels** for US plates with stacked symbols

2

INSTALLING AND POSITIONING CAMERA

2.1 Camera Installation

NOTE: Refer to PNO-A9081RLP, PNV-A9081RLP or PNB-A9001LP installation guide and follow the installation instructions.

2.2 Adjust for Plate "Rotation" Angle

For best results, check the angle of your plate compared to the horizontal angle and rotate the camera to less than 5° as shown below (Recommended Angle(s)).

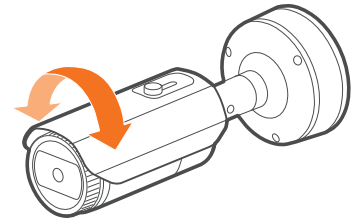

Recommended Angle(s)



5°max



>5°

2.3 LPR(ANPR)/ MMCR Specification



LPR(ANPR) CAMERAS

PNV-A9081RLP

PNO-A9081RLP

PNB-A9001LP

Solution	Community Traffic Observation / Parking Application		City Traffic Observation	Highways
Speed Description	Moderate Speed	Low speed	Regular Speed	High Speed
Lane Coverage	Up to 2 lanes	Up to 2 lanes	Up to 2 lanes	Up to 2 lanes
Speed limit	Up to 70kmh (45mph)	Up to 40kmh (25mph)	Up to 100kmh (65mph)	Up to 140kmh (90mph)
Min. Forward Distance	12m (38ft)	10m (33ft)	16m (52ft)	27m (90ft)
Max. Forward Distance	17m (55ft)	16m (52ft)	46m (150ft)	46m (150ft)
Max. Horizontal Angle	25°	30°	25°	15°
Max. Vertical Angle	25°	30°	25°	15°
Horizontal Offset	Up to 5m (18ft)	Up to 7m (24ft)	Up to 7m (24ft)	Up to 4m (12ft)
Camera Height	Up to 5m (18ft)	Up to 7m (24ft)	Up to 7m (24ft)	Up to 7m (24ft)
Vehicle Recognition	Make : 70+ Makes Model : 600+ models Color : 10 colors	Make : 70+ Makes Model : 600+ models Color : 10 colors	Make : 70+ Makes Model : 600+ models Color : 10 colors	Make : 70+ Makes Model : 600+ models Color : 10 colors

3 CONFIGURING YOUR CAMERA

NOTE: *There is no default user name and password to access the camera setting, 1) Please make your own user name and password at the first instance when you access the camera settings.*

2) Make sure to set correct date and time for the camera before going in to any additional settings.

3.1 Field of View

The below steps you will perform in the Wisenet camera configuration webpage

- 1) Configure camera so left and right are correct, not mirrored.
- 2) Set camera zoom to capture license plate
- 3) Adjust camera view angle so plate passes through the middle of the image.

3.2 Configure Initial Camera Settings

For proper operations, please, check and set properly:

- **Camera Date Time** (▶page 9)
- **IP settings** (▶page 10)
- **SD card storage** (▶page 13)
- **Camera exposure and focus** (▶pages 14~15)

SSDR, WDR, DIS, Defog, AGC and anti-flickering features are good for human eye but affect computer vision performance and therefore setting these to the least possible effect or turning off strongly advised.

3.2 (Continued)

[Date and Time]

WISENET PNO-AS081RLP admin Help

Basic **Date & Time**

Video profile
User
Date & Time
IP & Port

PTZ
Video & Audio
Network
Event
Analytics
Statistics
System

A Current system time
Date & Time 2000-01-03 21:14:13

Time zone
Time zone (GMT) Greenwich Mean Time : Dublin, Edinburgh, Lisbon, London
Daylight saving time Enable
Start time March.last.Sun/01:00:00
End time October.last.Sun/02:00:00
Apply Cancel

B System time setup
 Manual
Y - M - D 2000 - 01 - 03 h : m : s 21 : 13 : 57
 Synchronize with PC viewer
2021-03-15 16:49:10
 Synchronize with NTP server
Address 1 pool.ntp.org
Address 2 asia.pool.ntp.org
Address 3 europa.pool.ntp.org
Address 4 north-america.pool.ntp.org
Address 5 time.nist.gov
Apply Cancel

Choose **A** **Timezone** and set **Use daylight saving time** as appropriate.

Set **B** **date and time** or opt to **synchronize with your PC** or **NTP server**.

NOTE: *Wisenet Road AI app relies on these settings and if these are not set properly you may not see events in Wisenet Road AI app and events delivered to the outer systems may not contain proper timestamps.*

3.2 (Continued)

[IP, DNS, Ports]

The screenshot displays the 'IP & Port' configuration page in the Wisenet interface. The page is divided into two main sections: 'IPv4 setup' and 'IPv6 setup'. The 'IPv4 setup' section is highlighted with an orange border and contains the following fields:

Field	Value
IP type	DHCP
MAC address	00:09:18:61:A7:60
IP address	192.168.0.36
Subnet mask	255.255.255.0
Gateway	192.168.0.1
DNS setting by DHCP	<input type="checkbox"/> Use
DNS 1	168.126.63.1
DNS 2	168.126.63.2
Host name	PNO-A8081R-00091861A760
MTU	1500 (1280 - 1500)

The 'IPv6 setup' section is located below the IPv4 setup and contains the following fields:

Field	Value
IPv6 Enable	<input type="checkbox"/>
IPv6 IP type	Default
IPv6 IP address	
IPv6 Prefix	64

At the bottom of the page, there are two buttons: 'Apply' and 'Cancel'.

Proper IP, DNS and ports setting are important for:

- NVR and other integrations
- outside LAN access if required

NOTE: Reboot the camera whenever IP address gets changed.

3.2 (Continued)

[Go to App]

Please go to App in camera open platform section.

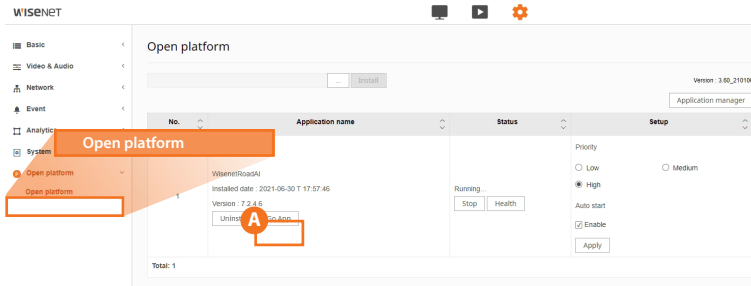

To run the Wisenet RoadAI app, select the **Open platform** menu and click the **A** **Go App** button in the **Application name** field.

3.2 (Continued)

[Go to App] (Continued)

Go to Wisenet Road AI application tab and select “Settings” from the pull down menu.

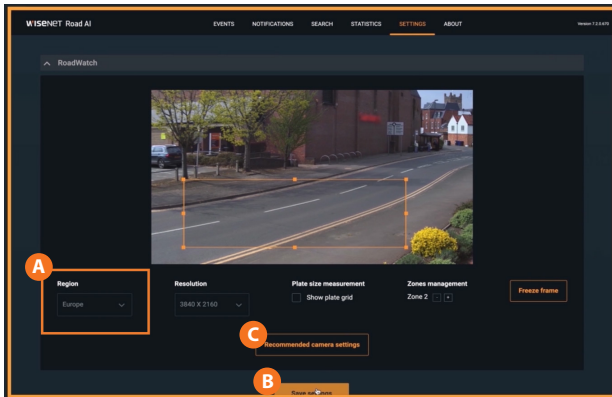

Select the **A** correct Region from the selection. Default settings will be “Europe”. If you are in any other regions other than the default (Europe) region, pull down the option and select the correct region/country that matches your usage.

Click **B** to **save the settings**.

In the same “Settings” section, you can also choose to have the **C** Recommend setting applied.



NOTE: You would need to go to the web menu of the camera → Open Platform Area to **D** Stop and Re-start the application to take the Regional setting changes to be effective.

3.2 (Continued)

[microSD card]

Your camera is supplied with micro SD card.

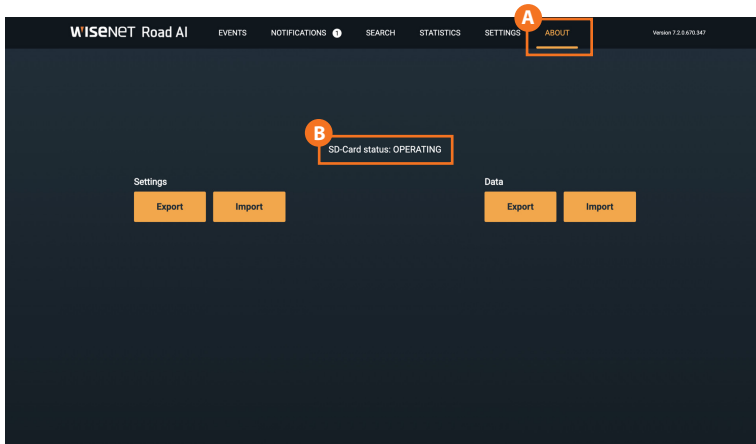

SD-card is managed by the Wisenet RoadAI application and no user interaction needed.

Please check the **B** SD-Card status in the **A** **ABOUT** section of the Wisenet RoadAI app.

Change the micro SD card if you see Error status

3.2 (Continued)

[Exposure adjustments]

Use the recommended settings from the Wisenet Road AI application in most cases. But if you need to manually adjust here are the most common settings that affect the LPR performance.

- A** Sensor: 25-30 fps
- B** SSDR: Off
- C** White balance: ATW
- D** Back light: Off
(try other backlight options only if camera gets blinded by headlights in the night)
- E** Exposure:
 - minimum shutter speed : 1/300
 - maximum shutter speed : 1/700
 - preferred shutter speed : 1/500
 - Anti flicker : Off
 - SSNR : Default
 - AGC : Low
- F** Day/Night:
 - Mode: Auto
- G** IR: manual
- H** Other settings: default

3.2 (Continued)

[Exposure adjustments-Automatic Gain Control]

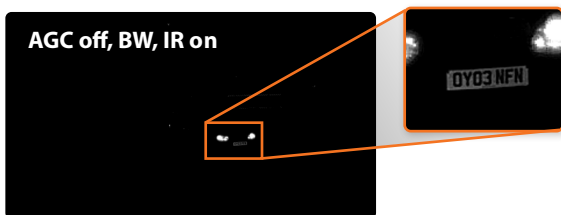

Automatic Gain Control can improve overall scene visibility notably. However, even at low setting AGC produces noise that can ruin license plate images, also lighter areas tend to bleach out. See illustrations to the left.

Start with turning AGC off. See the illustration to the left. Set AGC to low to improve plates visibility unless only other methods are helpful.

Adjust zoom so that real plate pixel width is at least 130px. Consider adjusting recognition zone so it is closer to the centre of the frame to avoid IR vignette effect.

NOTE: Do not use WDR as it decrease the shutter speed and may blur the vehicles.

3.3 Simple Focus on Plate Read Area

A unique feature of this camera allows you to select the plate area and hit a button to perform a “Simple Focus” on this plate area.

- 1 From the Video & Audio menu, select **Focus setup**.
- 2 Click and drag to draw an area of focus where the license plate is displayed.
- 3 Click the **Simple Focus** button to initiate a focus operation on the user-specified area.

NOTE:

The focus setting of PNB-A9001LP is related to the lens type, and manual focus is activated when using a manual varifocal lens.

The area indicated is not stored. If you need to perform a new Simple Focus, please draw a new area on-screen.

Set the focus to have plates in the proper pixel size.

- 130-300 pixels for regular EU plates
- 80-300 pixels for US plates without stacked symbols (small ones)
- 160-300 pixels for US plates with stacked symbols

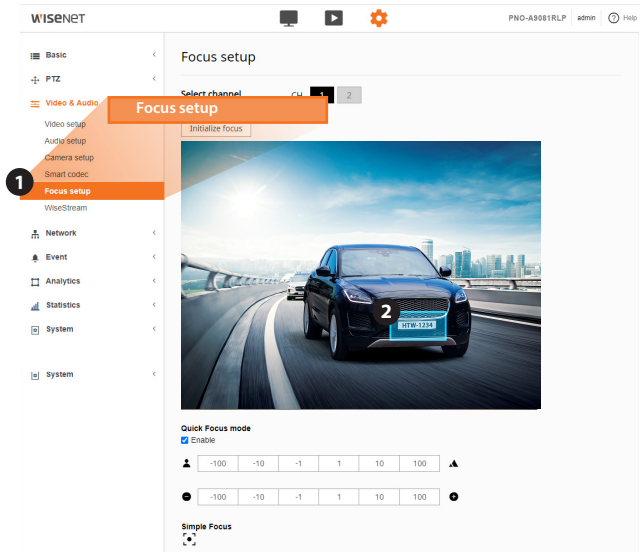

3.4 To measure pixel width of license/number plate

- 1 Spread or move license/number plate (cars) across the scene (see illustration on the left below) and take snapshots using web viewer capturing feature (**Live → Capture**);

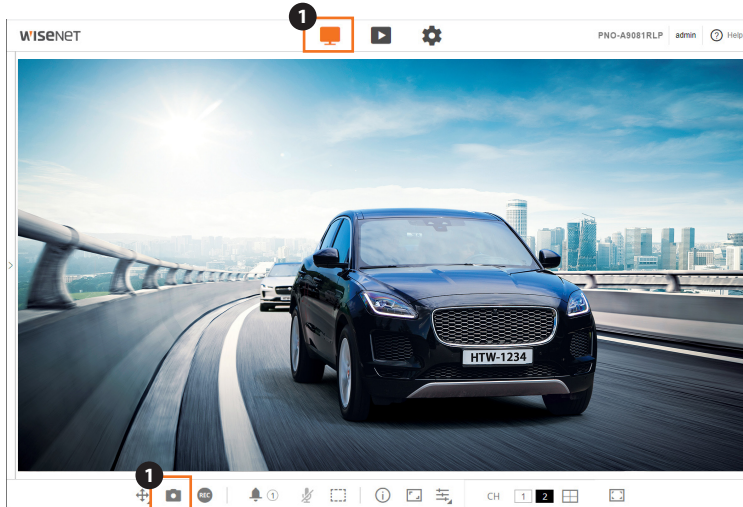

3.4 (Continued)

- 2 Use **Plate Grid** tool in the **Settings** tab of WisenetRoadAI and **Freeze Frame** feature to check whether plate fits the allowed range.
- 3 You can add an image from the Wisenet Road AI → **Settings** → Freeze frame to show the actual settings.

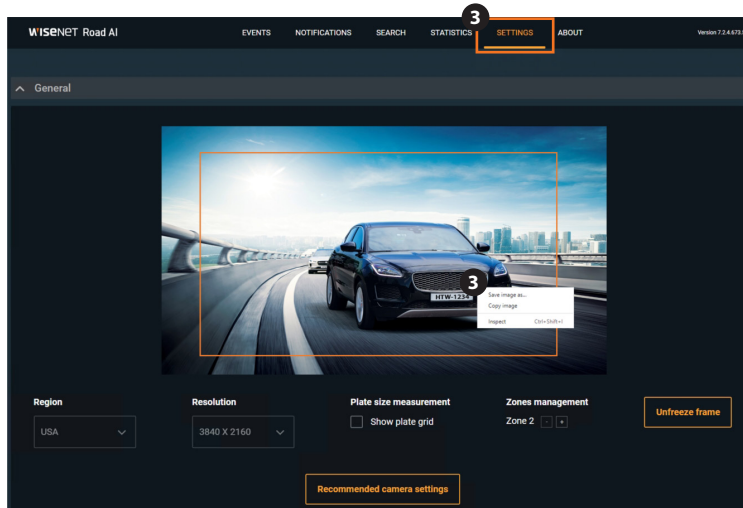

3.5 Observing PROPER Installation

SCENE REQUIREMENTS:



License/number plate is more than 130px in width



License/number plate is readable

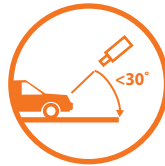

Vertical angle is less than 30°



Tilt angle is less than 5°

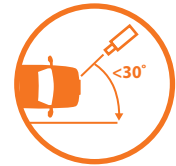

Horizontal angle is less than 30°

Fig. 1
Daytime



- good proportion to the frame width
- well lit
- sufficient contrast
- acceptable tilt angle

Fig. 2
Night time

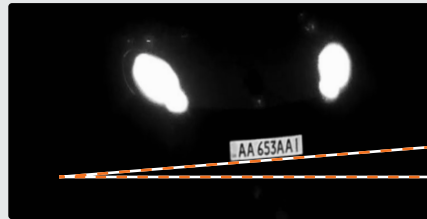

- good proportion to the frame width
- perfect IR power
- sufficient contrast
- critical yet acceptable tilt angle

3.5 (Continued)

POSSIBLE IR RESTRICTIONS:



The license/number plate is quite close to the frame boundary.
You may notice a vignette effect.

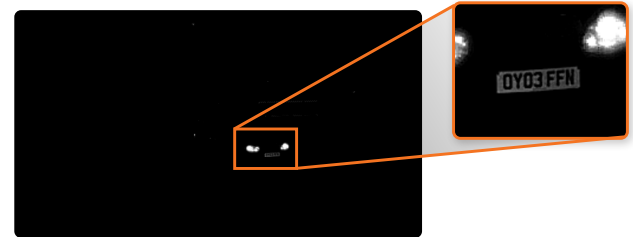

The license/number plate is closer to the centre of the frame.
The plate is lit much better.

Pay special attention to IR vignette effect (see illustration on the left) when setting up recognition zone. The closer to the center the more even lighting is.

Also in this particular case real pixel width of the license/number plate is critically small.

The Automatic Gain Control effect will be illustrated in camera exposure settings section.

3.6 Examples of IMPROPER Installation



Too small (less than 130px wide)
Tilt angle exceeds 5°

Focus and Shutter faults



Depth of field is insufficient to cover foreground license plates.
Adjust the lens settings.



Improper focus settings.
Adjust the lens.



Blurry image due to long exposure.
Fix the shutter speed to obtain sharper picture.

3.7 (Continued)

Exposure faults



Too much light. Either adjust the iris or shutter speed.
Night time: dim the IR or set AGC to Low.



Insufficient light. Adjust exposure settings or provide additional lighting.

For more information visit us at

Hanwha-Security.com



Head Office

6, Pangyo-ro 319beon-gil, Bundang-gu, Seongnam-si,
Gyeonggi-do, 463-400 Rep. of KOREA

Tel : +82.70.7147.8753

Fax : +82.31.8018.3740

<http://hanwha-security.com>

© 2021 Hanwha Techwin Co., Ltd. All rights reserved.

DESIGN AND SPECIFICATIONS ARE SUBJECT TO CHANGE WITHOUT NOTICE

Under no circumstances, this document shall be reproduced, distributed or changed, partially or wholly, without formal authorization of Hanwha Techwin Co., Ltd.

* Wisenet is the proprietary brand of Hanwha Techwin, formerly known as Samsung Techwin.